

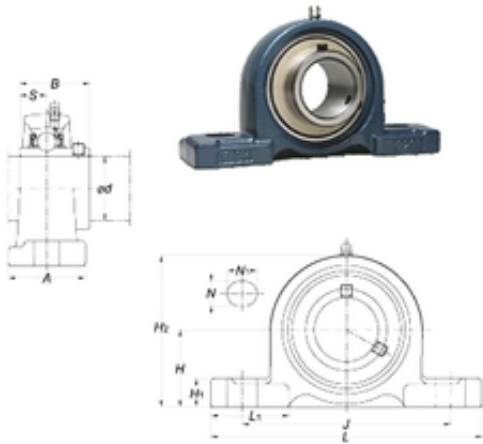

KFY MANUFACTURING MEXICO LIMITED

FYH UCPX11-35 bearing units



Bearing No. UCPX11-35

Bore Diameter	55,6525 mm
Width	65,1 mm
d	55,6525 mm
A	79 mm
B	65,1 mm
H	69,8 mm
H1	28 mm
H2	139 mm
J	184 mm
L	260 mm
L1	83 mm
N	25 mm
N1	36 mm
S	25,4 mm
Bolt (G)	M20
Weight	6,5 Kg
Basic dynamic load rating (C)	52,4 kN
Basic static load rating (C0)	36,2 kN

UCPX11-35 Bearing 2D drawings and 3D CAD models