

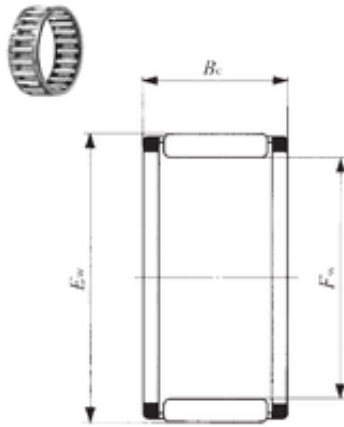

# KFY MANUFACTURING MEXICO LIMITED

## IKO KT 202612 needle roller bearings



Bearing No. KT 202612

Marchio	IKO
Diametro del foro	20 mm
Diametro esterno	26 mm
Fw	20 mm
Ew	26 mm
Bc	12 mm
Peso	0,012 Kg
Carico dinamico di base (C)	12,4 kN
Carico statico di base (C0)	14,3 kN

KT 202612 Bearing 2D drawings and 3D CAD models